



Single-Phase, Pump Control and Protection Module

BIA-SPC1-22 PN 802687

Installation and Operation Manual Rev 6.0



1. Introduction

Thank you for choosing a Bianco iCon SPC (Single Pump) Intelligent Pump Controller.

This SPC controller provides significant protection for a single, direct start (DOL), single phase pumps from 0.37kW – 2.2kW

The SPC Controller has a number of pre-programmed control and operation modes to suit a variety of applications.

The controller is easy to set up with a push button calibration.





The LCD screen displays the pump running state and provides the user a wealth of useful information.

A SPC controller is particularly useful where there is the need to control and protect pump installations managing the automatic operation by a variety of switching methods without the need to create a one-off control solution.







2. Contents

1. Introduction	2
2. Contents	2
3. ISO 7010 Symbols used in this manual.....	3
4. Warnings and Cautions.....	3
5. Quick guide to common button functions.....	4 - 5
6. Technical Specifications.....	6
7. Display	8 - 9
8. Electrical Connections.....	10
9. Parameter Calibration, erasing calibration and resetting.....	11
10. Communication link	12
11. Program Parameters	13 - 15
12. Quick guide: Drainage Pump, floats connected to panel	17
13. Quick guide: Drainage Pump with floats connected.	18
14. Quick guide: Pressure boosting	19
15. Quick guide: Transfer - source and destination control.....	20
16. Fault messages – possible causes and solutions.....	22
17. Warranties – Terms and Conditions	23

3. ISO 7010 Symbols used in this manual

	Warning - Electrical safety
	Warning – Potential consequences of use outside of intended application(s). Includes environmental condition warnings.
	Mandatory warning
	Warning to disconnect power
	Read carefully

4. Warnings and Cautions

	Read the manual carefully before starting and retain for future reference.
	Prior to starting installation or maintenance the controller must be disconnected from the power supply. Allow the internal electronics to discharge before opening the cover
	Any changes or modification to the wiring must be carried out by competent, skilled and suitably qualified personnel only.
	A qualified electrician should correctly size and install circuit breakers to protect the power supply. The fitment of additional surge protection is recommended.
	Never open the cover while controller is connected to electrical supply. Disconnect and allow the internal electronics to discharge before opening the cover
	This appliance is not intended for use by persons (including children) with reduced physical, sensory or mental capabilities, or lack of experience and knowledge, unless they have been given supervision or instruction concerning use of the appliance by a person responsible for their safety. Children should be supervised to ensure that they do not play with the appliance.
	Ensure the controller is a suitable size for the pump motor (see Section 6. Technical Data). Size according to P1 power.

5. Quick guide to common button functions

Switching to Manual mode (controller locked)



Hold   for 10 seconds to move from Auto to Manual mode.

The display will indicate  MODE. Any operational pumps will stop.

 The pump can now be operated manually by pressing Start / Stop as required.

 The display will indicate:

- the voltage available and
- the current (amperage) the pump is drawing.

If the amperage is outside of the programmed range the controller will stop the pump and display the relevant error code.

Last 5 error messages

Hold down  then press 

Repeated presses of

will cycle through the last 5 errors

Alarm Test

In  mode and pump(s) not operating press  for 3 sec to test the alarm.

Alarm Mute

AT ANY TIME press  to mute the alarm.

Returning to Automatic mode.

Short press  The display will indicate that the unit is in  mode.

Pump Protections

The control unit monitors voltage and current continuously. With the pump running, if a situation arises where the pump is operating outside of its programmed parameters i.e., dry run, overload, over voltage, etc, the control panel will shut down the affected pump and switch to the second.

The non-critical parameters will automatically re-set after the programmed period.

5. Quick guide to common button functions cont.

Pump Stalled

Pump stall alarms are considered a CRITICAL CONDITION. Generally, it indicates something jamming the impeller or in the case of a macerating pump, the cutting mechanism.

In the event of pump stall, open phase or other serious failure the controller requires manual resetting (power cycling) following pump inspection.

Pump accumulative running time

The SPC controller tracks how many hours the pump has run which enables the pump user to analyse the pump running conditions and schedule maintenance.

Ensure no pump is running

Hold   for 10 seconds to move from Auto to Manual mode.

The display will indicate  MODE. If the pump is operating, it will stop.

PRESS and HOLD the  key. Press  or

The control panel will beep and display the accumulative pump run time.

Press  to exit.

Pump Disable/Enable

The controller must be in  mode

Press  AND  TOGETHER to disable the pump.

Press  OR  TOGETHER to enable the pump.

Pump Calibration

Hold for   10 seconds.

The display will indicate  MODE.

Press  and allow the pump to run until it is running at its duty point and the amps stabilize.

Press  The control panel will beep. Press  to return to 

6. Technical Specifications

Controller Modes	Automatic or Manual pump operation. Liquid level control via float switch, level transducer or pulse electrode probes. Pressure control via pressure switch or transducer
Protection functions:	Dry run (underload), Overload, Pump Stalled, Transient surge, Under voltage, Over voltage, Repeated start, Over temperature, Short circuit
Input Voltage	230V +5% -10%
Rated output power	SPC1-22 0.37 – 2.2 kW P2 power (rated up to 25A input)
Working temp	-25 to +55 deg C 20% to 90% relative humidity, non-condensing
Controller size	302mm wide, 240mm tall, 120 deep. IP54
Trip response times (set)	Open phase – Less than 2 sec Short circuit – less than 0.1 sec
Trip Voltage (User adjustable)	Over voltage – Default = 115% of rated input voltage Under voltage – Default = 70% of rated input voltage default
Trip response times (User adjustable)	Dry run (Under-load) 6 sec Overload Default = 5 min Under Voltage Less than 5 sec Over voltage Less than 5 sec
Recovery times	Dry run (Under-load) 30 min default Overload 30 min default Under Voltage 5 min default Over voltage 5 min default
RS485 Technical interface	RS485 Bus Interface: asynchronous semi duplex 1200,2400,4800,9600 bps (default 9600bps) MODBUS protocol (RTU)
Alarms	Visual and audible alarm. Supports external alarm connection 12V 3W DC



Avoid installing the SPC where it could experience the following conditions:

- i. Where there is significant vibration and/or mechanical shock.
- ii. Where it could be exposed to corrosive liquids or gasses, or to flammable materials, solvents etc.
- iii. Extreme heat and cold. Operating range -25°C - 55°C.
- iv. Protect the controller from rain, moisture, humidity or dust



Remote Alarm

1. Position alarm on top of the enclosure and feed cable through hole with grommet
2. Fix alarm in place with hardware supplied
3. Mount controller inside enclosure using hardware supplied
4. Feed alarm cable through one of the cable glands and connect to terminal strip J22
5. Set dip switch beside J22 in the down position (In-built alarm OFF)
6. J22 terminals rated 12VDC 125mA, 1.5W

Cover

Part Number	Item Code	Description
BIA-iCOVER	802700	Metal enclosure for control panel with lockable door. Includes 803417 audio and visual alarm. 500W x 400H x 200D



Terminal strip J22 Toggle switches

7. Display

The SPC display provides a real time indication of the operational mode and the current state of the controller, including real-time voltage/current and any error messages.

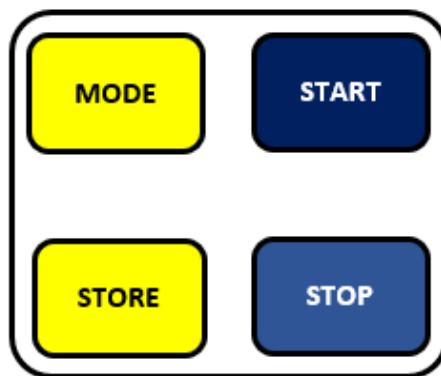
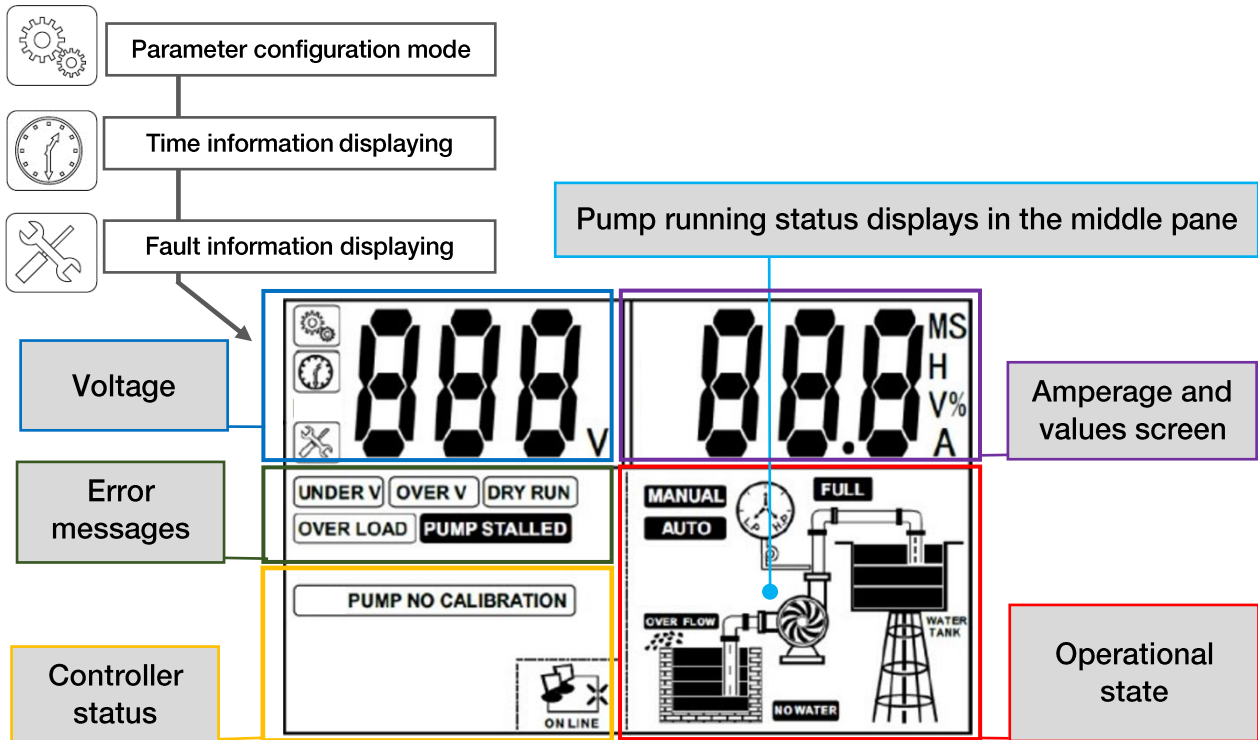

The controller is managed using the buttons on the front cover and a sequence of short, long and combination button presses as detailed in this manual



Remote monitoring and (limited) control can be achieved using the SC2 remote monitor

7. Display con't

The SPC controller operates according to pre-programmed logic applied to each 'mode'. Changing the Dip Switches inside the controller then **cycling the power** will activate the selected logic mode.

Examples of common applications are detailed at the rear of this manual but with an understanding of how the controller responds to various inputs in each of the modes the controller can be used for application other than what is suggested.

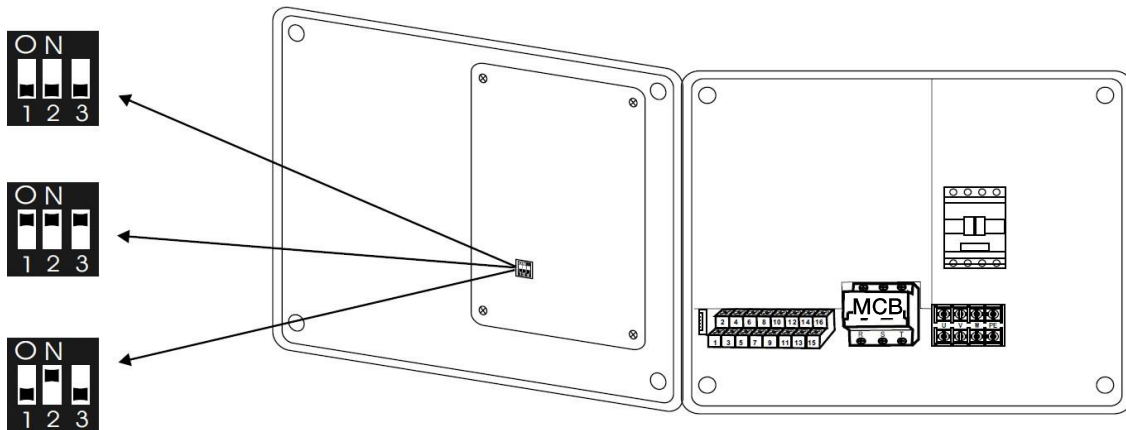

The appearance of the front display changes according to each mode and provides a visual indication to the state of the input signals.

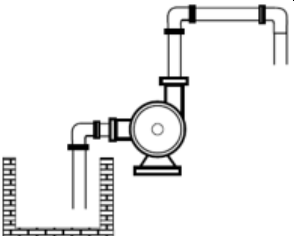
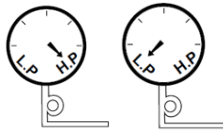
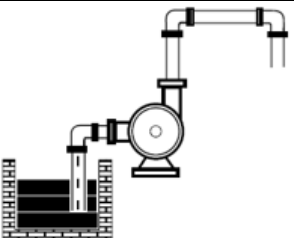
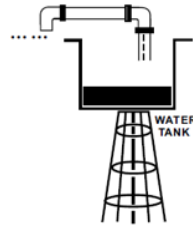
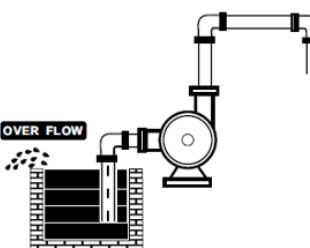
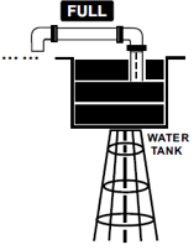
	Lack of source water		High pressure Low pressure
	Source water full		Destination low
	Overflow		Destination full

8. Electrical Connections

Always use an electrical outlet that is protected by Residual Current Device (RCD) Safety Switch with a trip current of 30mA or less. A Safety switch is required by Australian/New Zealand Standard AU/NZS 60335.1-2011.



This must be connected by a suitably qualified technician.

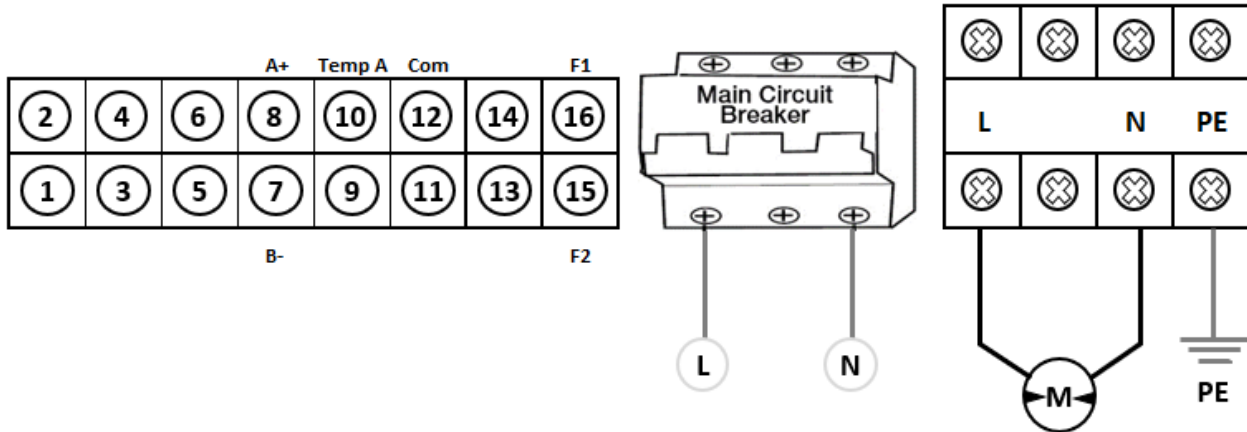

Other terminals.

Terminals 7 & 8 MODBUS communication to Slave Controller or BMS

Terminals 15 & 16 N.O. Close on fault

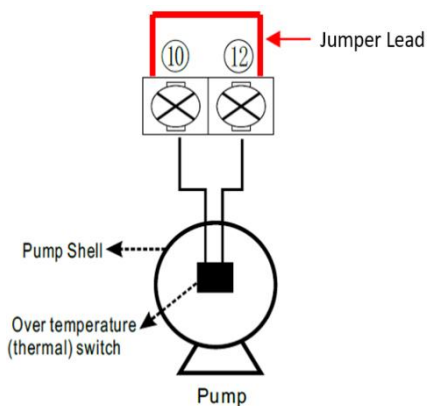

Terminals 10 & 12 for connection to motor thermal protection (microtherms) where available.

If the pump isn't fitted with microtherms, leave jumper wires in.

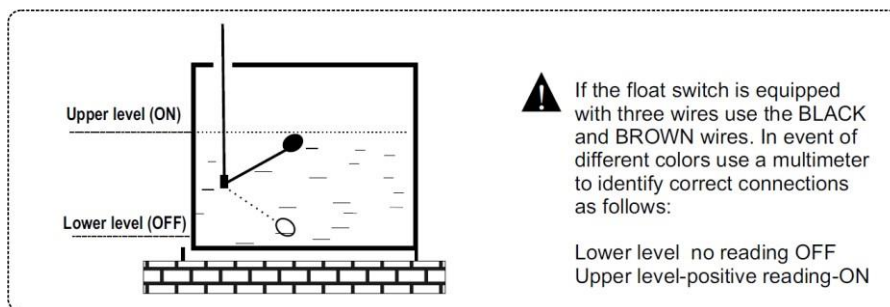

Float Down NC, Float Up NO

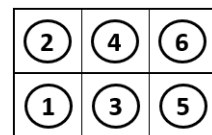

Terminals 1 – 6 are used to connect the control inputs (floats, probes, switches) as detailed in the setup guides

9. Parameter Calibration, erasing calibration and resetting



The pump must be able to pump water to enable correct calibration. Calibrated without water, overload and pump stalled errors may occur later.

Calibration can be performed automatically as detailed in the installation guides or by accessing the parameter menu and manually inputting the desired value

When a new pump is installed, or an existing pump reinstalled after maintenance, erase the former calibration and a perform a fresh calibration.

Erasing the parameter calibration

Press and Hold **MODE** **STORE** for 10 seconds to move from Auto to Manual mode.
The display will indicate **MANUAL** mode.

Press the **STOP** key for 30 seconds; the control panel makes a “beep” sound, and the control panel recovers the default factory setting and the LCD displays: No Calibration flashing.

Press **MODE** to return to **AUTO** mode.

Under auto state the control panel will run or stop the pump according to the signals from the liquid level probes, float switch, pressure switches or other connected inputs.

- **Note:** When a pump is running in **AUTO** mode and user wants to stop the pump, switch to **MANUAL** mode and the pump stops.
- Under **AUTO** mode, if the input power is cut off and the recovers, the control panel will enter an operational state after 10 seconds countdown.
- Whether in **AUTO** or **MANUAL** state, if the input power is cut off and recovers again, the control panel will resume its operation in the same state as before the power supply was interrupted.

Pump re-calibration

Press and Hold **MODE** **STORE** for 10 seconds if the unit is in Auto mode.
The display will indicate **MANUAL** mode

Press **START** and allow the pump to run until it is running at its duty-point and the amps stabilize.

Press **STORE** The control panel will beep. Press **MODE** to return to **AUTO**

10. Communication link

The control panel has communication interface, that along with the optional remote monitor user interface, it is possible to monitor and control the controller remotely.

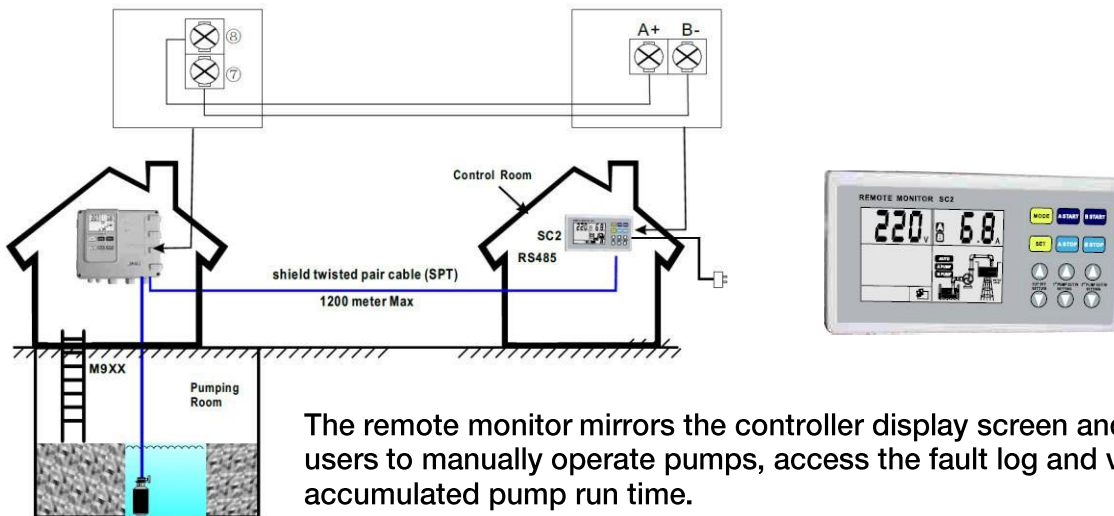

The remote monitor mirrors the controller display screen and allows users to manually operate pumps, access the fault log and view accumulated pump run time.

A USB-A to USB Mini-A can be used to connect and power the slave controller however there are limitations to the cable length that will work reliably.

The communication interface, wire communication distance is less than 1200 metres. For those installation environments which require a longer distance communication, users can adopt RS485 extender, wireless communication or GSM.

Please contact White International for more information.

Main technical data	
Physical interface	RS485 Bus Interface: asynchronous semi duplex
Data format	1 start bit, 8 data bit, 1 stop bit, no verify 1 start bit, 8 data bit, 2 stop bit, no verify Default: 1 start bit, 8 data bit, 1 stop bit, no verify
Baud rate	1200,2400,4800,9600 bps (default 9600bps)
Communication address	Setting range of controller address: 1-126. 127: broadcast address, host computer broadcasting, slave machine response forbidden
Protocol type	MODBUS protocol (RTU)
Rated input voltage for SC	AC 240V/50Hz, single phase
Main installation data	
Wire communication distance	1200 m max by shield twisted pair cable (STP)for RS485 & CAN 5000 m max by STP and RS485 extender
STP	STP-120U one pair 20AWG for RS485 & CAN
RS485 extender	5000 m (9600bps)

11. Program Parameters

Switch to Manual mode (controller locked)

Hold **MODE** **STORE** for 10 seconds.

The display will indicate **MANUAL** MODE. If the pump is operating, it will stop.













PRESS and HOLD **MODE** for 5 seconds to enter the parameter programming mode.

SHORT PRESS **MODE** to scroll through parameter menu.

SHORT PRESS **START** to increase a value. SHORT PRESS **STOP** to decrease a value.

PRESS to **STORE** exit.







This parameter list is current for Rev 6.0 firmware

<table border="1"> <tr> <td>001</td> <td>001</td> </tr> <tr> <td></td> <td></td> </tr> </table>	001	001			<p>The controller ID Used to identify a unit in a Modbus system</p> <p>Range 0 - 254 Default = 1</p>
001	001				
					
<table border="1"> <tr> <td>002</td> <td>004</td> </tr> <tr> <td></td> <td></td> </tr> </table>	002	004			<p>RS 485 Speed</p> <p>01 = 1200 bps 02 = 2400 bps 03 = 4800 bps 04 = 9600 bps</p> <p>Range 0 - 4 Default 4 = 9600 bps</p>
002	004				
<table border="1"> <tr> <td>003</td> <td>006^s</td> </tr> <tr> <td></td> <td></td> </tr> </table>	003	006 ^s			<p>Dry run protection trip response time in seconds (S)</p> <p>Range 0 seconds – 60 seconds Default value 6 seconds</p>
003	006 ^s				
					
<table border="1"> <tr> <td>004</td> <td>030^m</td> </tr> <tr> <td></td> <td></td> </tr> </table>	004	030 ^m			<p>Recovery time for dry run protection in minutes (M)</p> <p>Range 0 - 254 minutes Default value is 30 minutes</p>
004	030 ^m				
					
<table border="1"> <tr> <td>005</td> <td>005^m</td> </tr> <tr> <td></td> <td></td> </tr> </table>	005	005 ^m			<p>Overload trip response time in seconds</p> <p>Range 0 - 60 seconds Default value is 5 seconds</p> <p>The reset time is a non-adjustable value of 5 min. E.g., if the current is above parameter 009 for 5 seconds, controller stops pump for 5 min.</p>
005	005 ^m				
					

11. Program Parameters con't

<p>006 002^m</p> <p>UNDER V OVER V</p>		<p>Under / Over voltage trip response time in minutes (M)</p> <p>Range 0 – 60 minutes Default value is 2 minutes</p> <p><i>Under/Over voltage Parameters 012 and 013</i></p>
<p>007 14.0^A</p>		<p>Rated power output to pump</p> <p>Range – model dependant – See Pg 6 Default setting model dependant</p> <p>Button Press calibration saves the running value to this location</p>
<p>008 70[%]</p> <p>DRY RUN</p>		<p>The trip response ratio of the Dry-run (underload) protection as a percentage of the rated current</p> <p>Range 0 – 95% Default setting is 70%</p>
<p>009 125[%]</p> <p>OVER LOAD</p>		<p>The trip response ratio of the Overload Protection as a percentage of the rated current.</p> <p>Range 0 – 170% Default setting is 125%</p>
<p>010 170[%]</p> <p>PUMP STALLED</p>		<p>The trip response ratio of the Pump-Stalled Protection as a percentage of the rated current.</p> <p>Range 0 – 240% Default setting is 170%</p> <p><i>A pump-stalled event is a 'critical error' and has no auto-restart time</i></p>
<p>011 352^v</p> <p>OVER V</p>		<p>The trip voltage of the Under Voltage Protection (V)</p> <p>Default setting is 352V</p>
<p>012 477^v</p> <p>OVER V</p>		<p>The trip voltage of the Over Voltage Protection (V)</p> <p>Default setting is 477V</p>
<p>013 240^H</p>		<p><i>Note: Only Applicable to Drainage Mode</i> Anti-seize parameter.</p> <p>In auto mode, if pump has not run for XX hours, controller will run the pump for 3 seconds. Range 0 – 254 hours Default setting is 240 hours.</p>

11. Program Parameters con't

<p>014 005^m</p> 		<p>Auto Mute function of Alarm</p> <p>When controller is in Critical Alarm state, after time interval of 014 has expired, the alarm changes from continuous sounding to chirp mode at one minute intervals until the alarm condition is reset.</p>
<p>015 010^s</p> 		<p>Delay Start of pump in Auto Mode</p> <p>Once input sensors calls for pump to start, Timer 015 counts down and pump Starts Function used to prevent multiple, rapid starts of pump.</p>
<p>016 006^s</p> 		<p>Pump Stalled Delay on start up</p> <p>When in Drainage mode, some pumps such as Grinders draw very high current on start up. To prevent controller interpreting as a Pump Stalled occurrence, the functionality of 010 can be delayed via setting 017</p>
<p>017 00</p>  <p>PHASE REVERSAL</p>		<p>Phase Reversal Protection Function Selector</p> <p>00 – Phase Reversal function Active 01 – Phase Reversal function Active, but won't prevent pump start 02 – Phase Reversal function Inactive</p>
<p>018 015^m</p> 		<p>High level Audible Alarm & Lights delay</p> <p>When in Drainage mode, delays activation of audible alarm and warning light once high level float activated for duration of time set at 019 Allows pump to lower level when rapid level change occurs without causing nascent alarming. Value must be greater than 000</p>
<p>020 01</p>  <p>R S T OPEN PHASE</p>		<p>RST Open Phase.</p> <p>The control panel alarms, when a phase is dropped;</p> <p>Default = 01 - Enabled Setting the value to 00 disables this function</p>

Previous firmware versions have fewer parameters, and the default values differ.

Please contact White International for advice when dealing with earlier generation controllers.

If a replacement pump is installed, the previous calibration should be removed and a new calibration performed.



iCon SPC controllers are a cost effective, reliable means to provide better control and protection without the need for costly bespoke switchboards

The following quick guides provide information regarding common applications.

The pumps illustrated in the following quick guides are all of a submersible type but the SPC controller not limited to this type of pump.

With an understanding of how the controller responds to various inputs in each of the modes the controller can be used for applications beyond what is suggested.

For example, the controller can be connected in series with a VFD controlled pump to provide additional control inputs or to utilise the SPC controller delay times.

For even greatly flexibility in your installation the SPC controller can be used as a 'module' in a more complex control environment.



12. Quick guide: Drainage Pump, floats connected to panel

Set the dip switches on the inside of the door and cycle the MCB



DRAINAGE SETTING SWITCHES DOWN

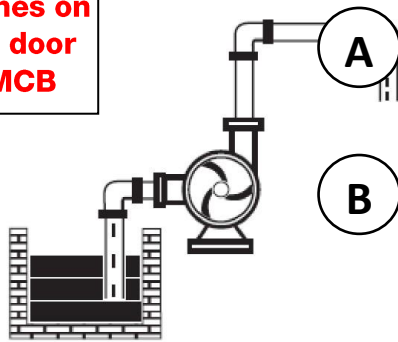

DRAINAGE SYMBOL

2 Floats connected Bridge 3 - 5

Lower level 1 - 5 Single pump runs (On/Off)

High Level (Overflow) 2 - 6 Buzzer sounds and alarm flashes
Pumps runs until Float A (1 - 5) switches off

3 Float operation No Bridge

Mid level (Optional) 3 - 5 To provide greater differential an additional float can be fitted between terminals 3 - 5
The pump will turn on via float 3-5
The pump will turn off via float 1-5

Terminals 10&12 are to connect microtherms. Leave jumpers in place.

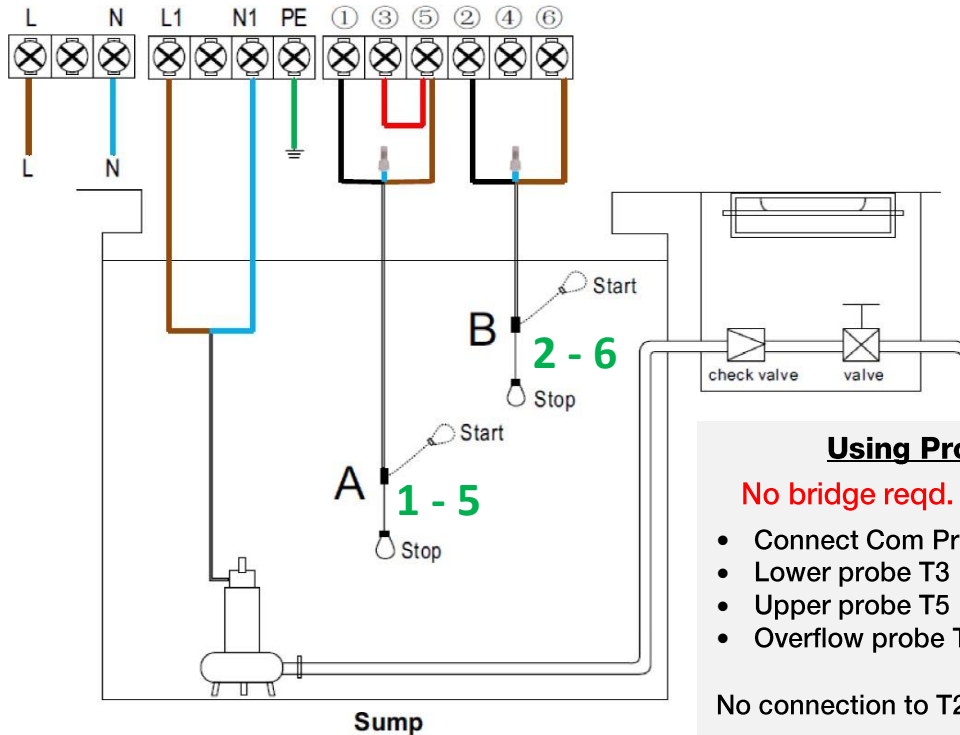

Sump

Using Probes

No bridge reqd.

- Connect Com Probe to T1
- Lower probe T3
- Upper probe T5
- Overflow probe T6

No connection to T2 necessary

Pump Calibration:

Press and Hold **MODE** **STORE** for 10 seconds to move from Auto to Manual mode.

The display will indicate **MANUAL** MODE

Press **START** and allow the pump to run until it is running at its duty-point and the amps stabilize.

Press **STORE** The control panel will beep. Press **MODE** to return to **AUTO**

13. Quick guide: Drainage Pump with floats connected.

Set the dip switches on the inside of the door and cycle the MCB



DRAINAGE SETTING FOR AUTOMATIC PUMPS

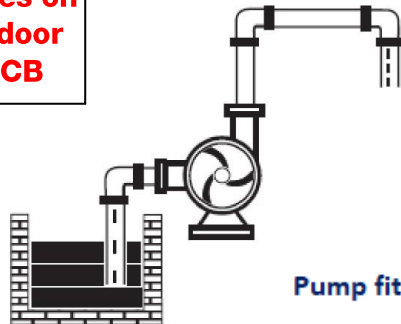

DRAINAGE SYMBOL

Pump fitted with float

Bridge 1-3-5

High Level 2-6 Buzzer sounds and alarm flashes (Overflow)

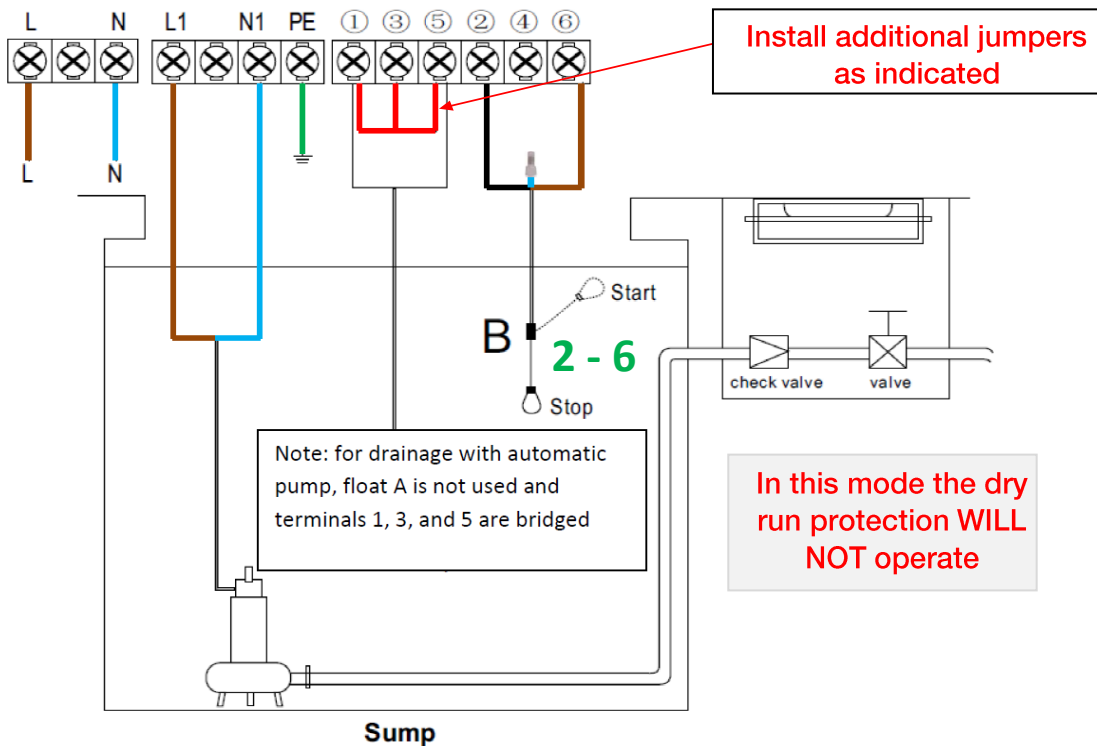

In this mode the dry run protection WILL NOT operate

Pump Calibration:

Press and Hold **MODE** **STORE** for 10 seconds to move from Auto to Manual mode. The display will indicate **MANUAL** MODE

Press **START** and allow the pump to run until it is running at its duty-point and the amps stabilize.

Press **STORE** The control panel will beep. Press **MODE** to return to **AUTO**

14. Quick guide: Pressure boosting

Set the dip switches on the inside of the door and cycle the MCB



BOOSTING SETTING SWITCHES UP

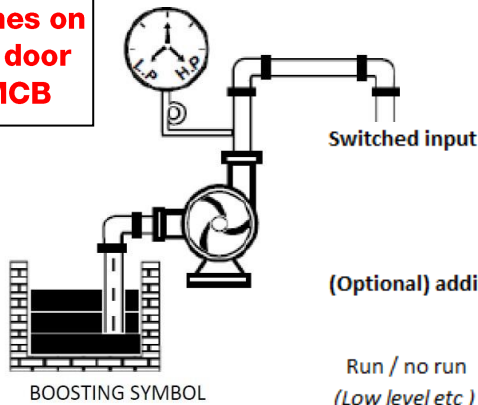

Terminals 10&12 are to connect microtherms
Leave jumpers in place

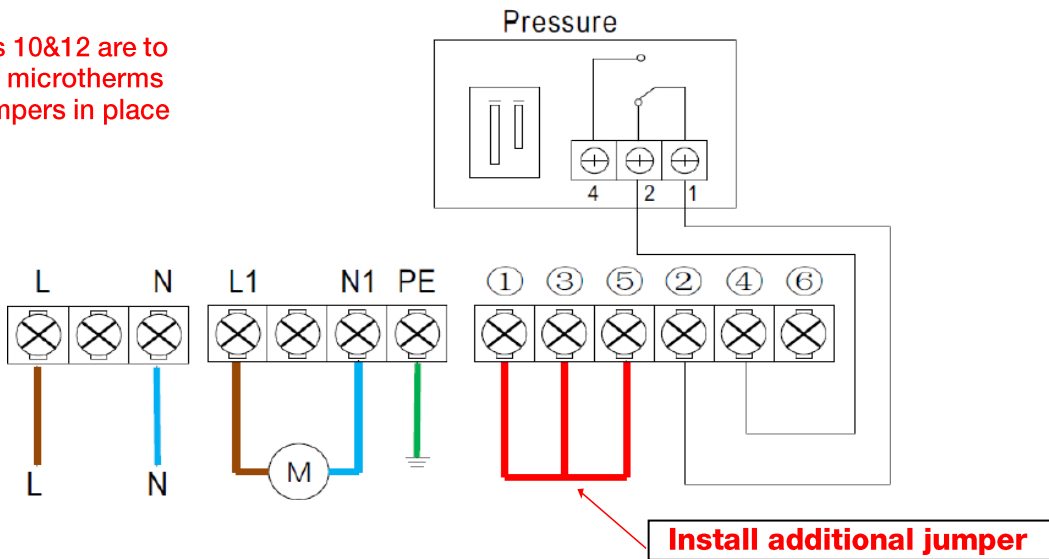

Additional RUN/NO Control can be achieved by removing the 1-3-5 jumper and connecting between the 1 - 5 terminals

When terminals **1 - 5** are open-circuit the pump will NOT RUN.

With **1 - 5** in a closed condition, the pump will run according to the **2 - 4** control circuit.

Pump Calibration:

Press and Hold **MODE** **STORE** for 10 seconds to move from Auto to Manual mode.

The display will indicate **MANUAL** MODE

Press **START** and allow the pump to run until it is running at its duty-point and the amps stabilize.

Press **STORE** The control panel will beep. Press **MODE** to return to **AUTO**

15. Quick guide: Transfer - source and destination control

Set the dip switches on the inside of the door and cycle the MCB



TRANSFER SETTING

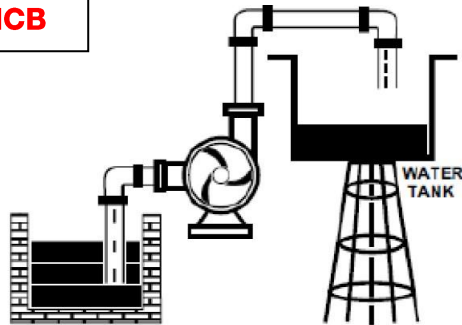

TRANSFER SYMBOL

Terminals 10&12 are to connect microtherms. Leave jumpers in place.

- Source level control 1 - 5** Bridge 4 - 6 and 3 - 5
Must be in the up (on) position for operation
Down (off) position prevents and/or stops all pumping.
- Destination level control 2 - 6** Must be in the down position for operation
Up position prevents and/or stops all pumping.

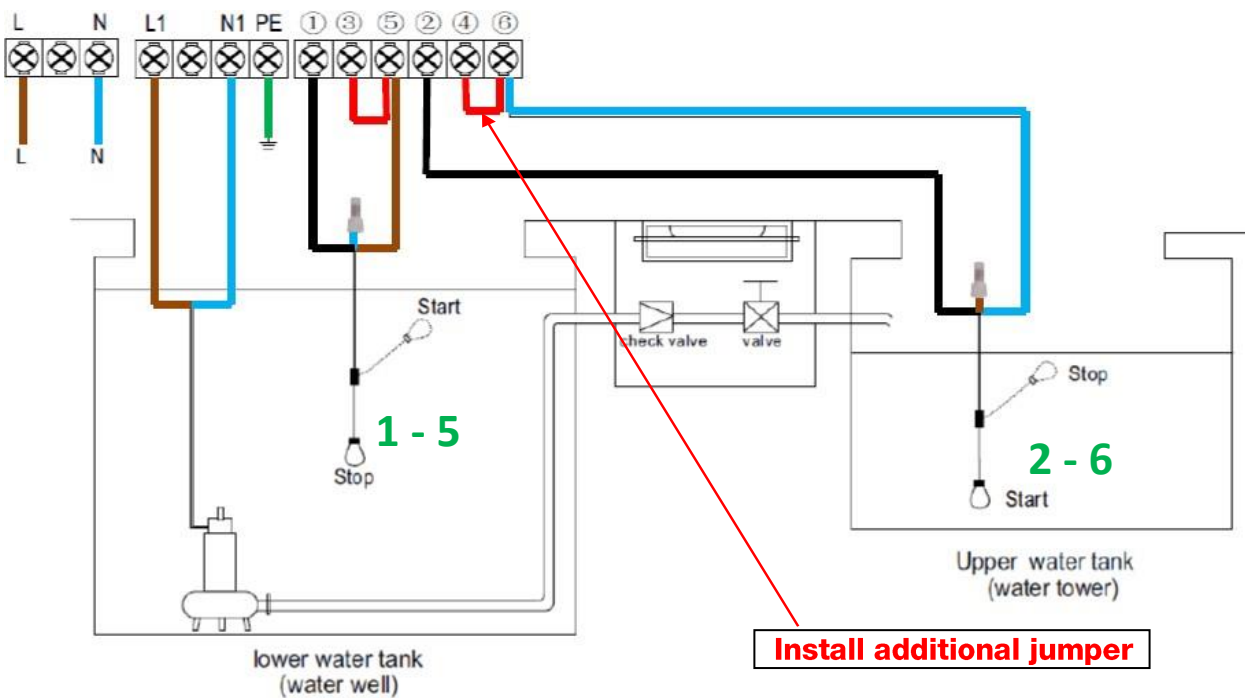

Pump Calibration:

← Refer to page 19

This page intentionally left blank

16. Fault messages – possible causes and solutions

Fault Message	Possible Cause	Solutions
Flashing PUMP NO CALIBRATION Parameter 007 or perform the auto calibration sequence	Pump calibration has not been completed.	See Pg 11 for calibration instructions.
Flashing DRY RUN Parameter 004 and 008	Water level in the well/sump is below pump intake, pump stops running. Broken outlet pipe	SPC will attempt to restart the pump every 30 minutes until water level restored.
Flashing OVER LOAD Parameter 005 and 09	Pump running amps greater than calibrated running amps, pump is in overload protection state. Pump damage, dragging impeller or bearing, possible clogging. Pump calibrated without water or with a nominal amperage value	SPC will attempt to restart the pump every 30 minutes until running amps restored to normal. Inspect and/or repair pump. Erase previous calibration and recalibrate with water.
Flashing PUMP STALLED Parameter 010	Pump running amps greater than 200% of calibrated running amps Pump Stalled protection indicates a 'Critical Error' suggesting obstruction to the impeller or cutting mechanism	Cut off power supply, inspect, repair or replace pump.
Flashing UNDER V Parameter 006 and 011	Voltage is lower than the calibrated voltage. The pump is in under voltage protection state.	SPC will attempt to restart the pump every 5 minutes until normal voltage is restored.
Flashing OVER V Parameter 006 and 012	Voltage is higher than the calibrated voltage. The pump is in the over-voltage protection state.	SPC will attempt to restart the pump every 5 minutes until normal voltage is restored.
Flashing REPEATED START	Pump starts more than 5 times per minute. <i>It is less likely that this could occur in drainage or transfer mode unless there is a wiring fault.</i>	Check pressure switch settings are correct for application. Check pressure tank pre-charge pressure and condition of diaphragm (if fitted) Check the volume of sump is not too small.
Flashing OVER TEMP	The jumper on temperature protection terminals has been removed. Pump motor temperature high and pump thermal switch in open state (if connected).	Reinstall jumper on temperature protection terminals. Wait until pump motor temperature reduces. Investigate cause for Overheating.
 ON LINE	No communication between Slave controller and SPC Distance to SC excessive	Connect remote monitor to enable remote monitoring/control

17. Warranties – Terms and Conditions

This warranty is given in addition to the consumer guarantees found within the Australian Competition and Consumer Act 2010 (Cth) for goods purchased in Australia and the Consumer Guarantees Act 1993 NZ for goods purchased in New Zealand:



1) White International Pty Ltd / White International NZ Ltd (White International) warrant that all products distributed are free from defects in workmanship and materials, for their provided warranty period as indicated on the top or opposite side of this document. Subject to the conditions of the warranty, White International will repair any defective products free of charge at the premises of our authorised service agents throughout Australia and New Zealand if a defect in the product appears during the warranty period. If you believe that you have purchased a defective product and wish to make a claim under this warranty, contact us on our Sales Hotline on 1300 783 601, or send your claim to our postal address or fax line below and we will advise you as to how next to proceed. You will be required to supply a copy of your proof of purchase to make a claim under this warranty.

2) This warranty excludes transportation costs to and from White International or its appointed service agents and excludes defects due to non-compliance with installation instructions, neglect or misuse, inadequate protection against the elements, low voltage or use or operation for purposes other than those for which they were designed. For further information regarding the suitability of your intended application contact us on our Sales Hotline on 1300 783 601. If you make an invalid claim under this warranty, the original product will be sent back to you unrepai red.

3) This warranty refers only to products sold after the 1st January 2012, and is not transferable to another product type and only applies to the original owner, purchaser or end user, and is in addition to the consumer guarantees found within the Competition and Consumer Act 2010 (Cth) for goods purchased in Australia and the Consumer Guarantees Act 1993 (NZ) for goods purchased in New Zealand.

4) Our goods come with guarantees that cannot be excluded under the Australian Consumer Law. You are entitled to a replacement or refund for a major failure and for compensation for any other reasonably foreseeable loss or damage. You are also entitled to have the goods repaired or replaced if the goods fail to be of acceptable quality and the failure does not amount to a major failure. 2 YEAR WARRANTY

5) To the fullest extent permitted by law, White International excludes its liability for all other conditions or warranties which would or might otherwise be implied at law. To the fullest extent permitted by law, White International's liability under this warranty and any other conditions, guarantees or warranties at law that cannot be excluded, including those in the Competition and Consumer Act 2010 (Cth), is expressly limited to: (a) in the case of products, the replacement of the product or the supply of equivalent product, the payment of the cost of replacing the product or of acquiring an equivalent product or the repair of the product or payment of the cost of having the product repaired, is at the discretion of White International or a 3rd party tribunal elected under the Competition and Consumer Act 2010 (Cth) for goods purchased in Australia and the Consumer Guarantees Act 1993 (NZ) for goods purchased in New Zealand; and

6) To the fullest extent permitted by law, this warranty supersedes all other warranties attached to the product or its packaging.

7) In the case of services, supplying the services again or the payment of the cost of having the services supplied again, is at the discretion of White International or a 3rd party tribunal elected under the Competition and Consumer Act 2010 (Cth) for goods purchased in Australia and the Consumer Guarantees Act 1993 (NZ) for goods purchased in New Zealand. 8) Our warranty commences from the date of purchase of the above-mentioned pumps. Proof of purchase is required before consideration under warranty is given.

Record your date of purchase in the space below and retain this copy for your records.

Date of Purchase**Model Purchased**



www.whiteint.com.au
www.whiteint.co.nz

1300 783 601
0800 509 506

Please always refer to our website for further technical information & new product innovations

Disclaimer: Every effort has been made to publish the correct information in this manual. No responsibility will be taken for errors, omissions or changes in product specifications.

© 2020 Copyright White International Pty Ltd

TM ® - WARNING: Please be aware that various brands & products depicted within this document are subject to trademark, patent or design registrations. Infringement of any intellectual property contained within this document without express written authority by the appropriate intellectual property holder may result in further legal action to be taken. For any queries regarding use of the contained information please feel free to contact White International Pty Ltd.